

Self-Disclosure

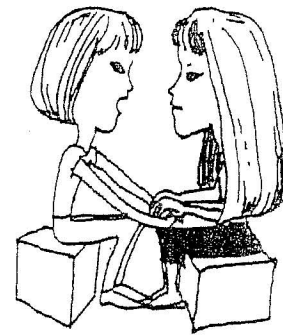

Complete the following statements to gain an increased understanding of your SELF. You may want to DISCLOSE these thoughts and feelings to someone special to enhance your relationship.

- I am most content when _____

- My hopes and dreams for the future are _____

- I like myself most when _____

- I like myself least when _____

- My greatest fear is _____

- I feel disappointed when _____

- People think I am _____

- I value most _____

- One negative trait about myself is _____

- One positive trait about myself is _____

I'm going to share these thoughts and feelings with _____

Self-Disclosure

I. PURPOSE:

To promote self-disclosure with others in order to improve communication skills and strengthen relationships.

To increase self-awareness and self-understanding.

II. GENERAL COMMENTS:

Acknowledging and understanding one's own values allows greater potential for self-disclosures and honest communication between individuals. Self-understanding has the potential to positively influence relationships.

III. POSSIBLE ACTIVITIES:

A. 1. Prepare activity by taking one handout and cutting ten strips of paper from the ten open-ended statements. Fold, and place in hat.

2. Generate discussion regarding self-disclosures, communication, and relationships.

3. Encourage each group member to choose a strip of paper from the hat, read aloud, and complete the self-disclosure statement. Place paper into hat when finished.

4. Continue with all group members for a designated time period.

5. As a closure, ask all group members to identify one significant person they plan to share their self-disclosures with, and how it might affect that relationship.

6. Process benefits of this activity.

B. 1. Distribute handouts, encouraging group members to complete the sentences, writing their responses on the lines provided.

2. Facilitate a discussion of each statement, encouraging individuals to share.

3. As a closure, ask all group members to identify one significant person they plan to share their self-disclosures with, and how it might affect that relationship.

4. Process benefits of this activity.

COMMUNICATION

BUILDING BLOCKS

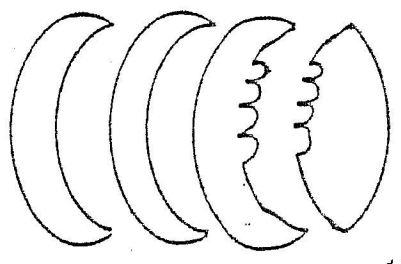
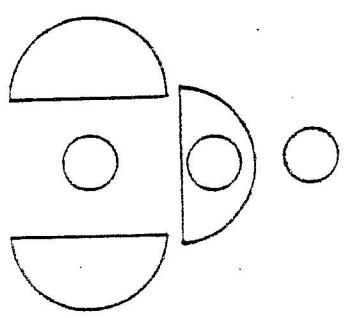
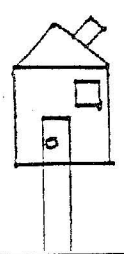
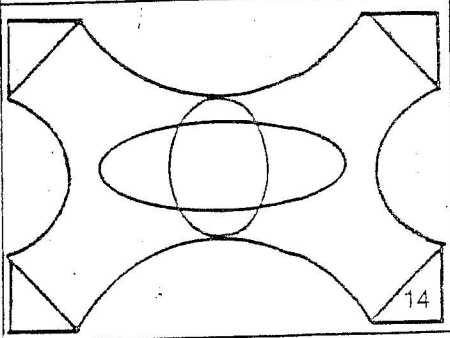
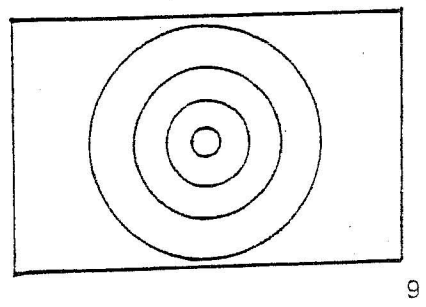
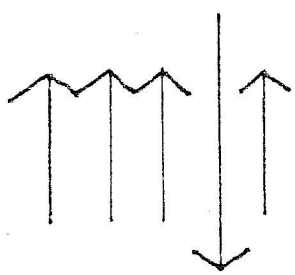
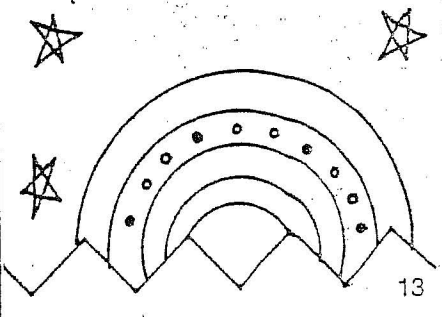
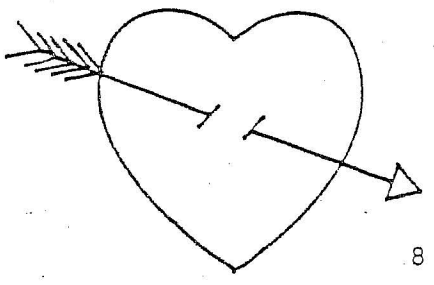
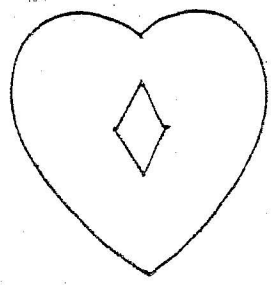
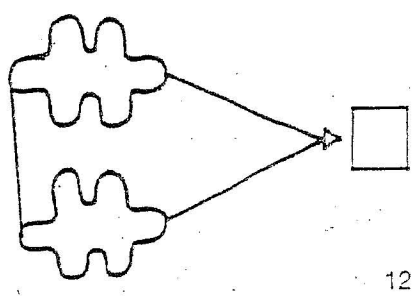
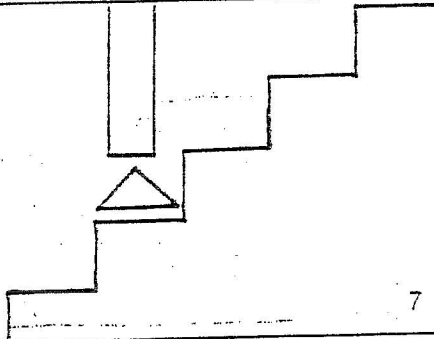
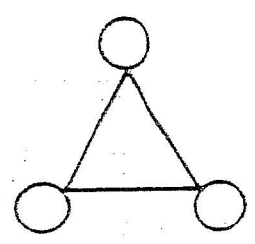
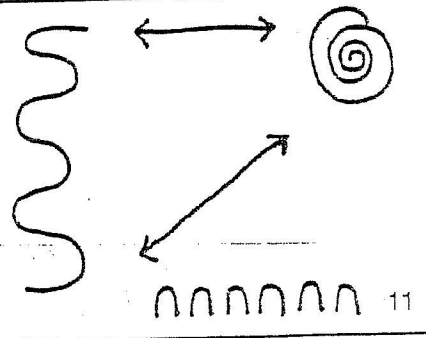
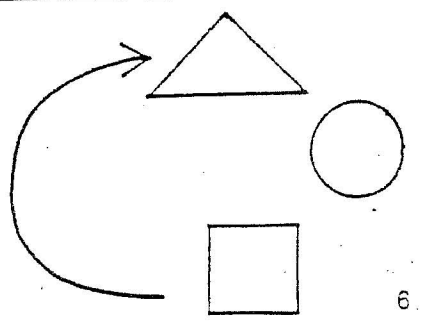
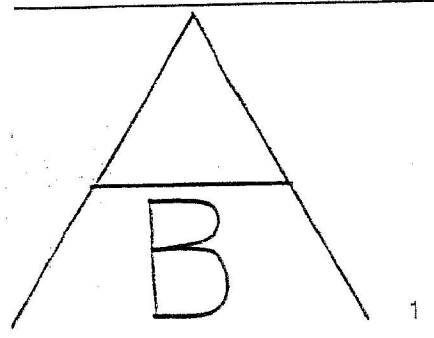

COMMUNICATION BUILDING BLOCKS

I. PURPOSE:

- To increase an awareness of verbal, nonverbal, one-way and two-way communication.
- To promote open communication.

II. GENERAL COMMENTS:

Open communication which involves verbal, nonverbal, and two-way communication offers the clearest picture to the receiver. Effective communication promotes improved personal and professional relationships.

III. POSSIBLE ACTIVITIES:

- A.
1. Photocopy 1 handout.
 2. Distribute blank paper and pencils to all group members.
 3. Ask for a volunteer, and instruct him/her (without showing the handout to others) to...
 - a. choose one shape.
 - b. describe it to the group using verbal cues only so the others can accurately draw it on their papers. Use one-way communication only. Do not allow questions/comments from the group. Do not use nonverbal cues (hand motions, body gestures, etc.).
 4. Encourage group members to show their drawings to the describer to compare their copies with the original.
 5. Continue the activity by instructing volunteer #2 to describe a different shape verbally, but this time including nonverbal cues as well. Use one-way communication only.
 6. Encourage group members to draw, and then show their drawings to the describer to compare their copies with the original.
 7. Continue the activity by instructing volunteer #3 to describe a third shape verbally and nonverbally allowing for two-way communication with group members.
 8. Process the group by discussing members' reactions and responses to each of the 3 exercises, emphasizing the benefits of verbal, nonverbal and two-way communication.
- B.
1. Photocopy one page and make cards of each of the twelve designs.
 2. Encourage group members to describe their shapes to the rest of the group. They can choose to describe them... (a) verbally, with no nonverbal cues; (b) verbally and nonverbally, allowing no questions; or (c) verbally and nonverbally, encouraging questions.
 3. Process the group by discussing members' reactions to the exercise, and emphasizing the benefits of open communication.

BENEFITS OF:

- ① VERBAL
- ② NON-VERBAL
- ③ Two-way communication

CONVERSATION SKILLS

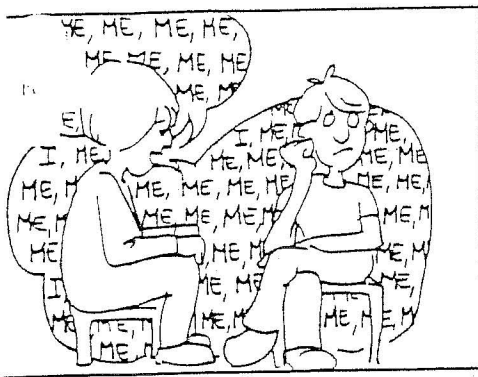

IS
WHERE
IT'S
AT!



Sometimes, when we first meet people, it's difficult to start up a good conversation. What to talk about? What not to talk about? How often do you...

| | ALWAYS | SOMETIMES | NEVER |
|--|--------|-----------|-------|
| > Face and look directly into the eyes of the person you are talking to. | _____ | _____ | _____ |
| > Avoid overusing "I". (Sometimes people talk a lot about themselves because they're nervous.) | _____ | _____ | _____ |
| > Make sure you focus and listen when the person responds. | _____ | _____ | _____ |
| > Try bringing up something that's neutral - weather, recent movies or TV shows, current events, etc. | _____ | _____ | _____ |
| > Try to be honest, but not too honest. (Honesty is a good quality in relationships, but it can be overdone.) | _____ | _____ | _____ |
| > Give sincere compliments. | _____ | _____ | _____ |
| > Accept compliments by saying "Thank You". | _____ | _____ | _____ |
| > Avoid touchy subjects, like religion, politics or overly personal information from your past. | _____ | _____ | _____ |
| > End a conversation with a pleasant phrase - "Nice meeting you", "Hope to see you again", "It's been nice talking to you", etc. | _____ | _____ | _____ |

Looking at the marks above, which do you do best in conversations? _____

Which area do you feel you need to work on the most? _____

Conversation skills, like all skills, take time and practice. GIVE IT A TRY!

CONVERSATION SKILLS

I. PURPOSE:

To increase communication by improving conversation skills when first meeting people.

II. GENERAL COMMENTS:

Effective conversation skills are helpful, if not vital in a variety of settings, such as work, social and even in treatment settings. Many people feel awkward when meeting people for the first time, sometimes out of nervousness, lack of positive experiences, low self-esteem, etc. The skill of starting up a good conversation eases a first encounter and can be a fun and non-threatening skill to learn in a group setting. It is important to recognize that first impressions do last and that first encounters often make or break relationships.

III. POSSIBLE ACTIVITIES:

- A.
 1. Introduce topic in above stated GENERAL COMMENTS.
 2. Distribute handouts and review the nine friendly guidelines.
 3. Write potential social situations on index cards that the group might encounter, such as day treatment program, singles group, self-help/support group, bowling club, church/temple, work, parties, civic groups, etc. Be specific in the description, e.g., *you are at a party from church and someone you don't know asks you who you are and what you are doing there.* Try and touch on the skills outlined in the handout. Ask each group member to write one situation, if able.
 4. Explain to the group that everyone is encouraged to do at least one role-play to learn the skills outlined AND to have fun!
 5. Distribute one index card per group member and proceed with role-plays.
 6. Offer feedback on skills observed.
 7. Process the group by asking group members what specific skill each group member will remember after the group is finished.
- B.
 1. Explain the topic briefly.
 2. Ask which behaviors each group member would like and would not like to see when first meeting someone. Make a list on the board.
 3. Distribute the handouts and compare the list on the board with the handouts' list.
 4. Engage the group in a discussion of the following:
 - When do we overuse "I"?
 - How can we tell that we have talked about ourselves too much?
 - What are certain topics to try to remember as neutral topics?
 - What is good body language when first meeting someone?
 - What is a good physical distance between people?
 - What does "active listening" mean?
 - How can we show people that we are "actively listening" to what they are saying?
 - What is too honest in a first meeting?
 - When do we tend to negate or slough off compliments? Why do we do that?
 - What are certain topics to avoid in a first meeting?
 - What information would you NOT share in a first encounter?
 - What are common signals that tell you a conversation is ending?
 5. Ask group members to write inside the arrow, in ranking order, what skills they most need to work on (the skill that needs the most work is "1", the skill that least needs work is a "9").
 6. Process the group by discussing groups' commonalities or differences as well as potential places/situations to work on these important skills.

LISTENING SKILLS



IS
WHERE
IT'S
AT!

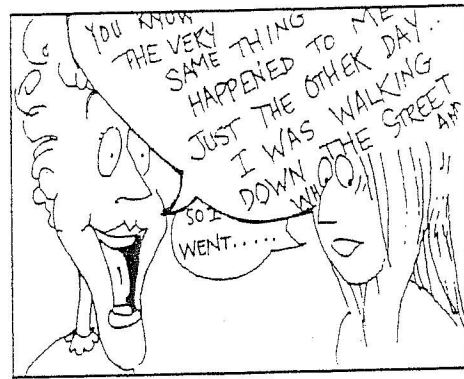

Listening is a major part of a healthy communication process and an important skill.

How would you rate your listening skills? How often do you ...

ALWAYS SOMETIMES NEVER

| | | | |
|---|-------|-------|-------|
| ➤ Put aside what you're doing. | _____ | _____ | _____ |
| ➤ Focus your eyes on the speaker. | _____ | _____ | _____ |
| ➤ Think about what the speaker is really saying. | _____ | _____ | _____ |
| ➤ Avoid 'stepping on the other person's words'. | _____ | _____ | _____ |
| ➤ Show interest with facial & body gestures. | _____ | _____ | _____ |
| ➤ Respond with a non-judgmental attitude. | _____ | _____ | _____ |
| ➤ Ask interested questions, remembering points for next discussion. | _____ | _____ | _____ |
| ➤ Try not to overdo when bringing your own experiences into the discussion. | _____ | _____ | _____ |

Looking at the marks above, which do you do best as a listener? _____

Which area do you feel you need to work on the most? _____

Listening skills, like all skills, take time and practice. GIVE IT A TRY!

LISTENING SKILLS

I. PURPOSE:

To increase communication by improving listening skills when engaged in conversation.

II. GENERAL COMMENTS:

Effective listening skills are helpful in every situation throughout each person's day. They enable one to understand what is being told to them, have healthy relationships, be a part of group, etc. The skill of listening, opposed to just "being there" when someone is talking, is an important tool to acquire. "Active listening" requires not only hearing the words but also hearing the feelings behind the words, seeing the situation through the eyes of the speaker and not judging the speaker.

III. POSSIBLE ACTIVITIES:

- A.
 1. Introduce topic in above stated GENERAL COMMENTS.
 2. Distribute handouts and review the eight listening hints.
 3. Prior to the group write possible situations on index cards. A few might be: "You ask a relative how they are feeling and they proceed to tell you, for the next 15 minutes", "Your best friend has a devastating problem and discusses it with you", "You meet someone nice at the store and they start a conversation with you", etc. Ask each group member to write one situation, if able.
 4. Explain to the group that everyone is encouraged to do at least one role-play. This helps to learn the skills outlined AND to have fun!
 5. Place cards face down in a hat and ask two people to pick one and role-play, one being the speaker and the other being the listener. After each person has done one role-play, encourage the pair to pick another card, reversing the roles.
 6. Offer feedback on observed listening skills.
 7. Ask group members to mention some friends, family members and professionals whom they feel have excellent and/or poor listening skills, encouraging them to give an example of how that person listens, and how they feel when this occurs.
 8. Process by asking what skills group members would like to improve on and note if there are commonalities or differences.
- B.
 1. Explain the topic of listening.
 2. Distribute handouts and discuss the eight listening hints.
 3. Decide on a topic that could be a lively group discussion, e.g., a current event, a movie, or a controversial subject such as capital punishment, etc.
 4. Form subgroups of three or four and blindfold each group member. Instruct the group to discuss the chosen topic for five minutes amongst themselves.
 5. Take off the blindfolds and discuss another topic for five minutes.
 6. Process the activity by asking group members to discuss how it felt to listen without seeing faces and expressions, and then with, noting the difference.